

Likorall

242/243/250

Quick Reference Guide

English

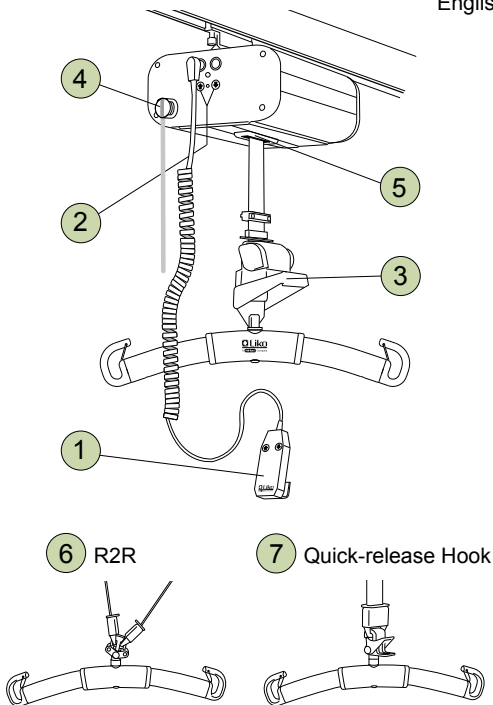

1 Hand Control

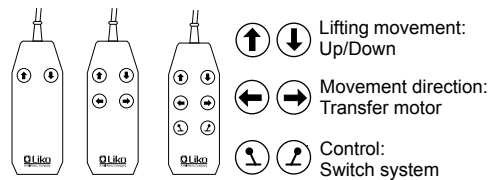

HandControl IR:

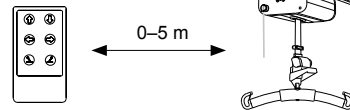

2 Emergency Lowering/Raising (Electrical)

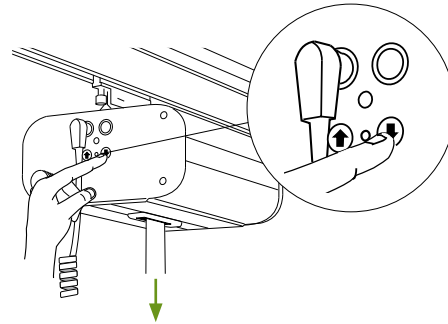

3 Mechanical Emergency Lowering

Exclusively: 242 S, ES

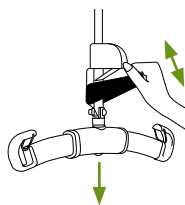

Activate:

Press down repeatedly on the emergency lowering handle.



Reset:

Remove load from the lift strap. Hold the emergency lowering handle down at the half-way position while at the same time turning the black knob clockwise.

4 Emergency Stop

Activate:

Alt. 1

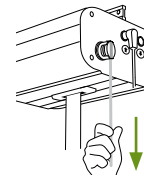

Alt. 2

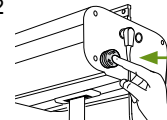

Reset:

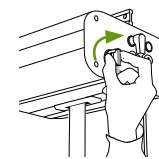

5 SSP Limit Switch

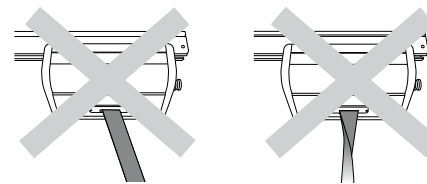

The lifting motion is interrupted when load on the lift strap is biased or when the lift strap is twisted.

6 7 Sling Bar Connection

6. The R2R sling bar has hooks for two lift straps to enable transfer between two lifts.

7. A sling bar with a Quick-release Hook enables fast and easy exchange of sling bars.

Charging of Batteries

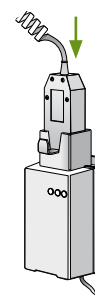

- Charge the lift regularly after use.
- The lift does not function during charging.
- **Ensure that the emergency stop is not pressed in during charging.**

Safety Instructions

- Read the instruction guides for the lift and lifting accessories before use.
- Before the patient is lifted from the underlying surface, but after the straps have been fully extended, make sure the straps are properly connected to the sling bar.
- **Max. load Likorall 242: 200 kg (440 lbs).**
Max. load Likorall 243: 230 kg (507 lbs).
Max. load Likorall 250: 250 kg (550 lbs).

To retain max. load it is essential to use accessories rated for the same max. load or greater.

IMPORTANT!

This quick reference guide does not replace the lift's instruction guide, which can be downloaded from www.liko.com.

Ergonomics

- Never lift manually – let the lift do the lifting.
- Take it easy. Work calmly and methodically.
- Don't strain your back! Work in a walking stance with your back straight.
- Use the bed's raising and lowering functions.
- Reduce the lever effect. Work close to the patient and the lift.

Cleaning

When necessary, clean the lift with a moist cloth, using common surface cleaners or disinfectants.

Simple Troubleshooting

Check to ensure that:

- emergency stop is not pressed in
- the battery is charged
- the hand control is properly connected
- the mechanical emergency lowering device has been reset.

Other Quick Reference Guides

Quick reference guides for Liko's lifts and slings are available for downloading from www.liko.com.

© Copyright Liko AB



A Hill-Rom Company

www.liko.com

Manufacturer:

Liko AB
SE-975 92 Luleå
Sweden
info@liko.se